

# ACL Reconstruction

Using ToggleLoc™ Device with ZipLoop™ Inline  
Technology and TunneLoc® Tibial Fixation

Surgical Technique

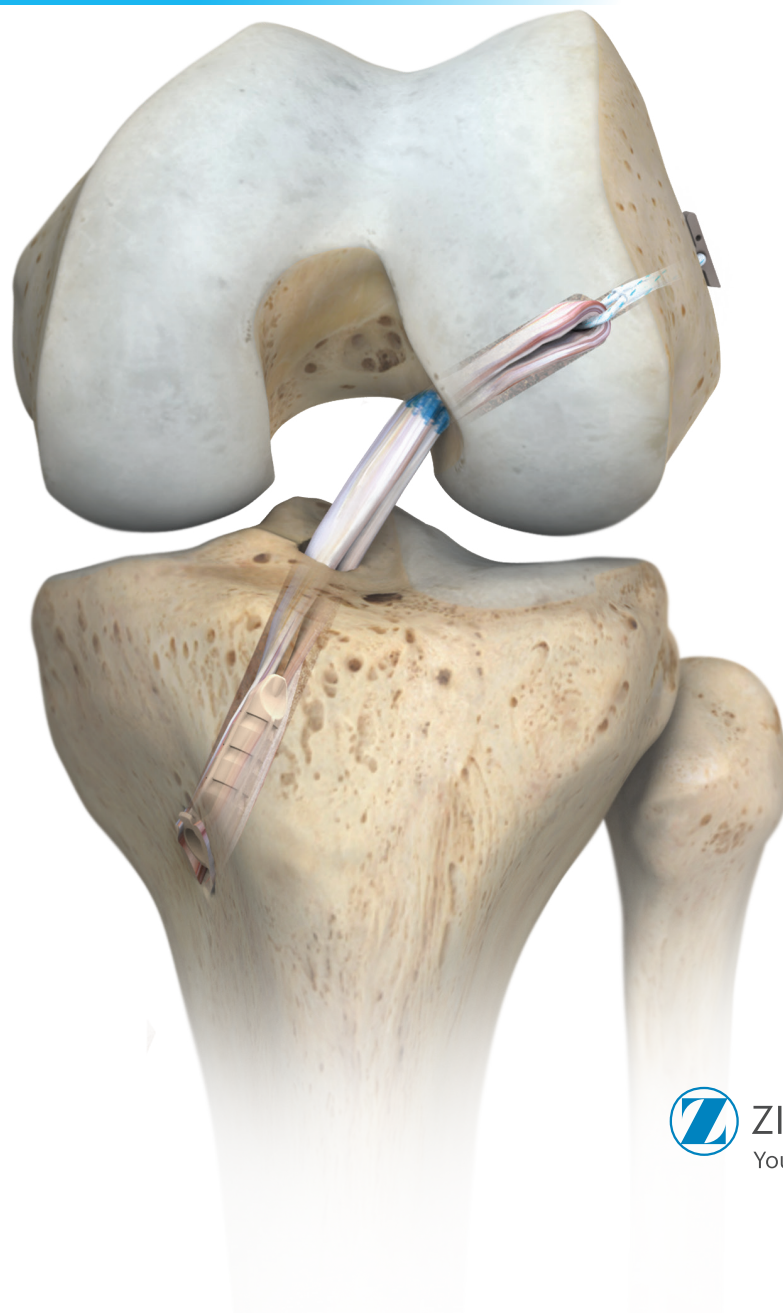

## Surgical Technique

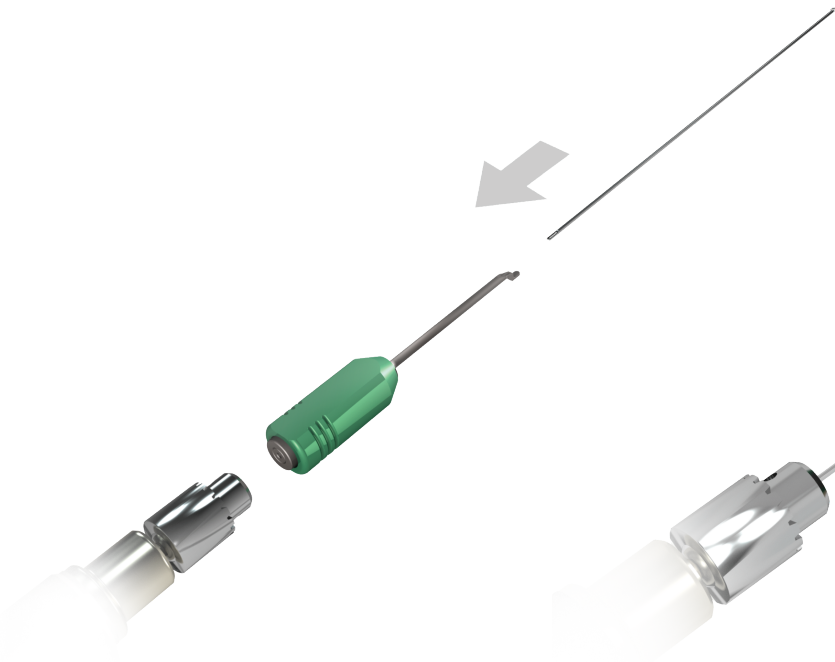

Figure 1

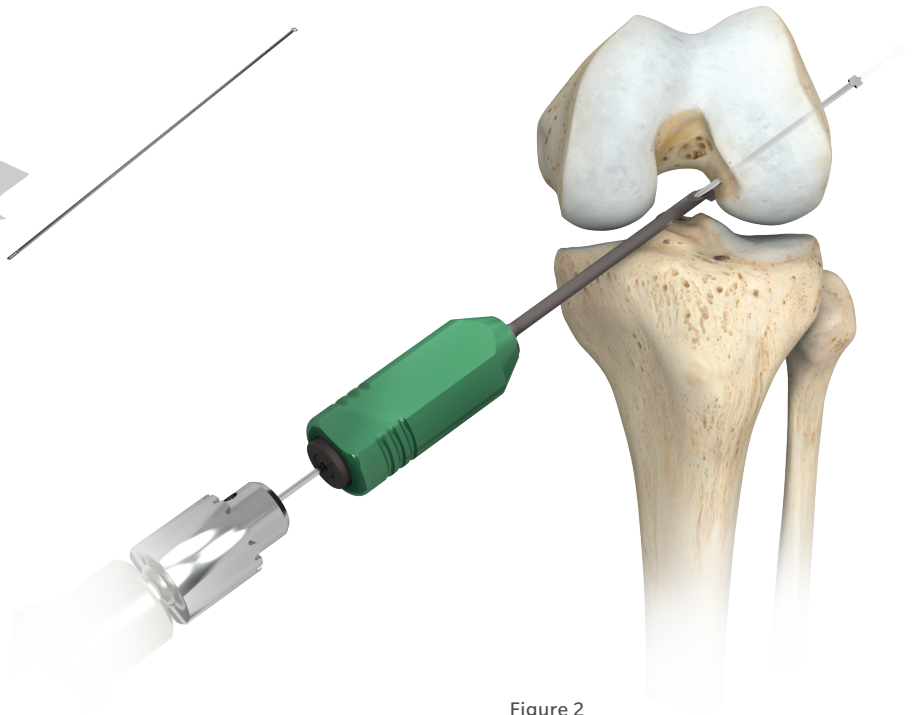

Figure 2

ⓘ **Note:** This implant can be utilized through a transtibial or medial portal approach.

### Femoral Tunnel Preparation

Load the spade tip beath pin into the femoral aimer. Make note to load the spade tip beath pin through the front of the femoral aimer prior to chucking into the drill (Figure 1). Insert the femoral aimer and spade tip beath pin into the medial portal or the accessory medial portal.

Once the femoral aimer is in position, drill the 4.5 mm spade tip beath pin through the lateral femoral cortex (Figure 2). Alternatively, a femoral aimer is not necessary per surgeon's preference.

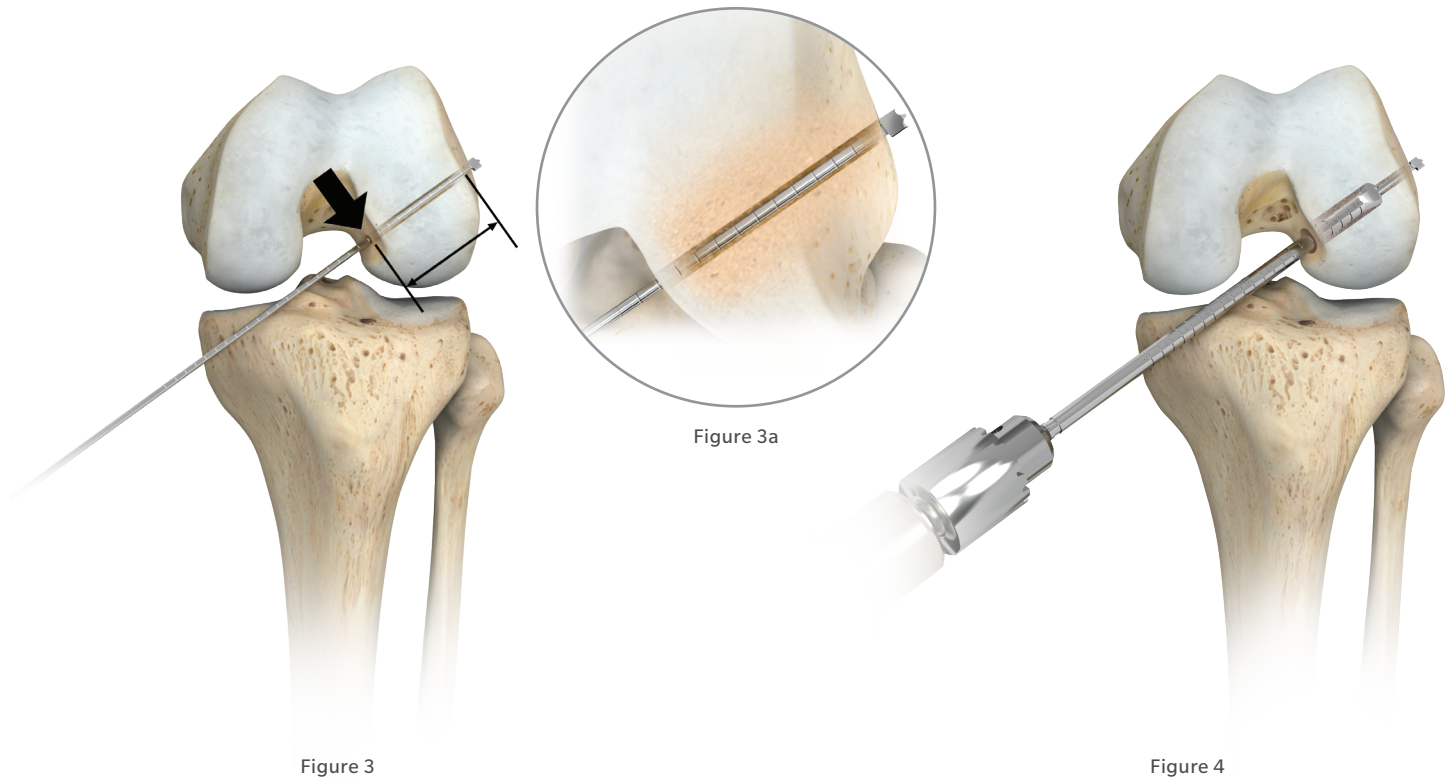

### Femoral Tunnel Preparation (cont.)

Catch the spade tip beath pin on the outer edge of the lateral femoral cortex and note the intraosseous distance by reading the depth marking closest to the femoral notch (Figures 3 & 3a).

Size the diameter of the graft and choose the corresponding low profile reamer. Ream over the spade tip beath pin to the depth desired leaving a minimum 5-7 mm bone bridge (Figure 4). Make sure to note the depth of the femoral socket for later use and do not remove the spade tip beath from the femoral tunnel.

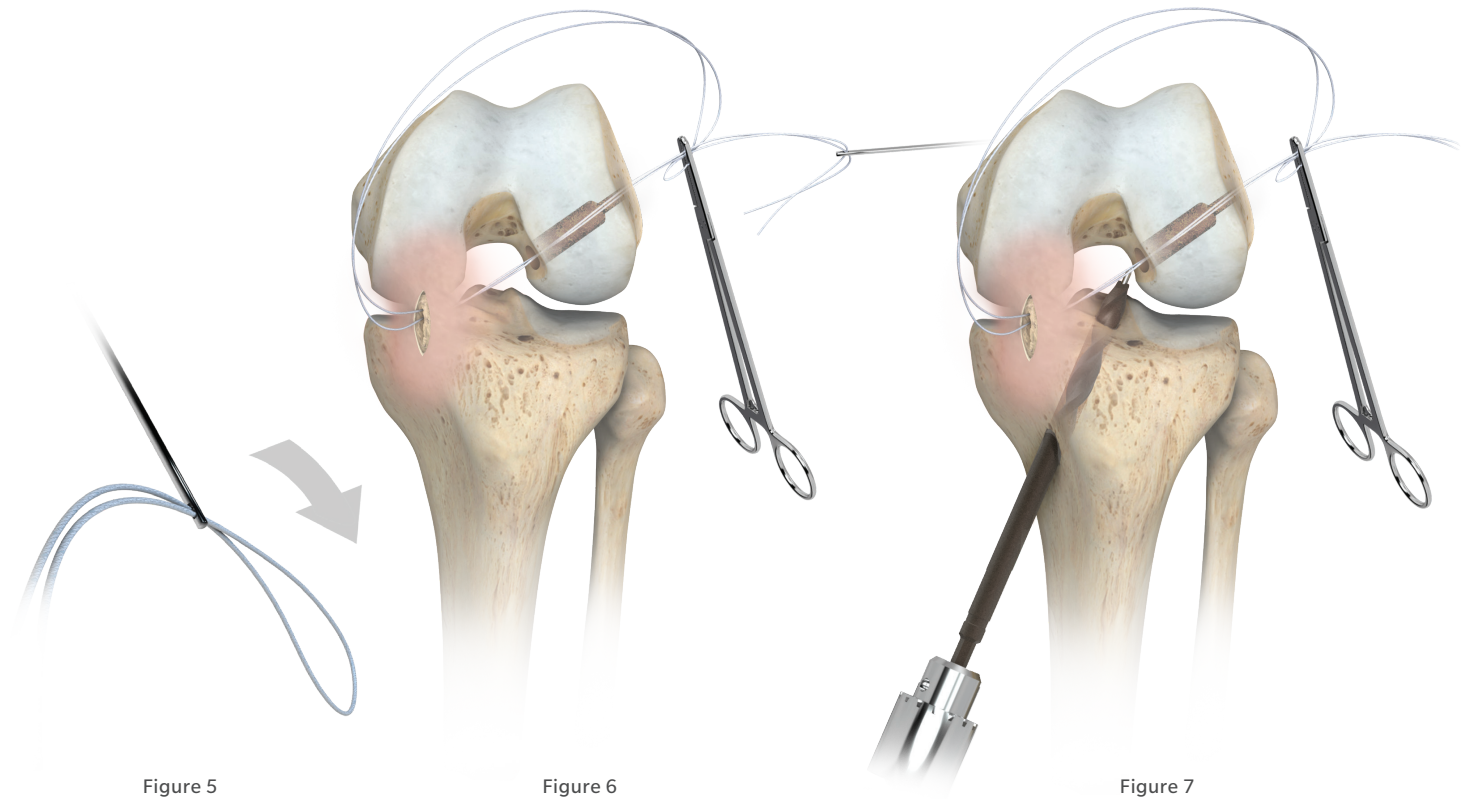

Figure 5

Figure 6

Figure 7

### Prepare the Relay Stitch

Thread the free ends of a #2 MaxBraid™ suture through the eyelet of the spade tip beath pin (Figure 5). Pull proximally on the spade tip beath pin to place the relay suture into the joint space and through the femoral tunnel. Remove the spade tip beath pin once the free ends of the #2 MaxBraid suture exit the skin. Using a hemostat, clamp the loop end of the relay stitch that is exiting the medial portal to the free ends of the relay stitch that are exiting the skin on the lateral thigh (Figure 6).

### Tibial Tunnel Preparation

Prepare the tibial tunnel by using a tibial guide. Place the tunnel in the anatomic position on the tibia. Drill a 2.4 mm guide wire through the guide. Ream over the guide wire with the corresponding reamer to the previously determined graft size (Figure 7).

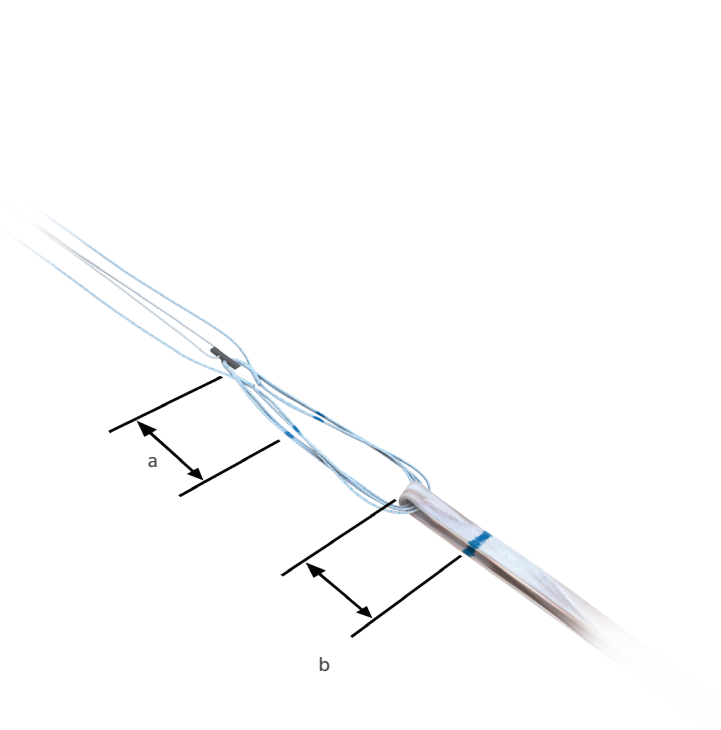

Figure 8

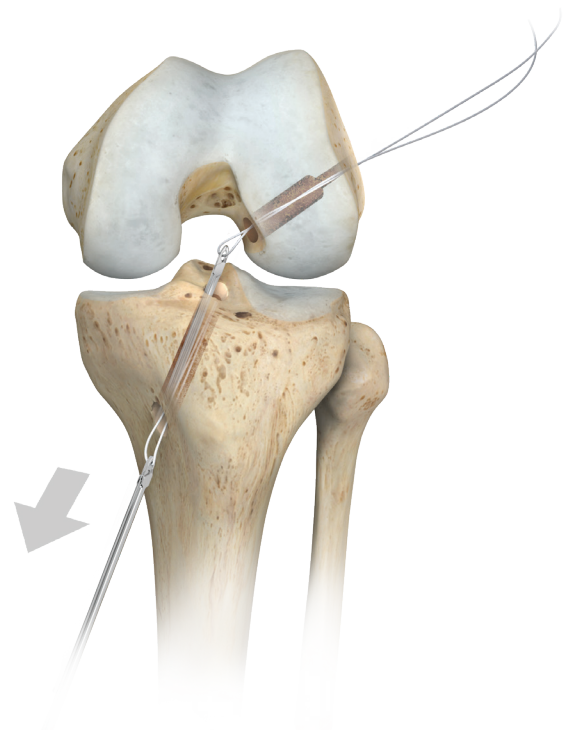

Figure 9

### Prepare ToggleLoc Device with ZipLoop Inline Technology

Leave the implant in the white cardboard packaging for preparation. Pass the soft tissue grafts through the loops of the ToggleLoc Inline device. Use the measurement previously obtained from the spade tip beath pin to mark the loops of the implant to ensure deployment on the lateral cortex. Measure from the distal end of the ToggleLoc device toward the loops and mark a line (a) (Figure 8).

Mark the graft at the corresponding femoral socket depth previously drilled (b) (Figure 8). This mark will aid in optimal graft positioning later in the procedure.

### Insert Implant into Tunnel

Enter the tibial tunnel with a suture grasper or crochet hook to retrieve the looped end of the relay suture (Figure 9).

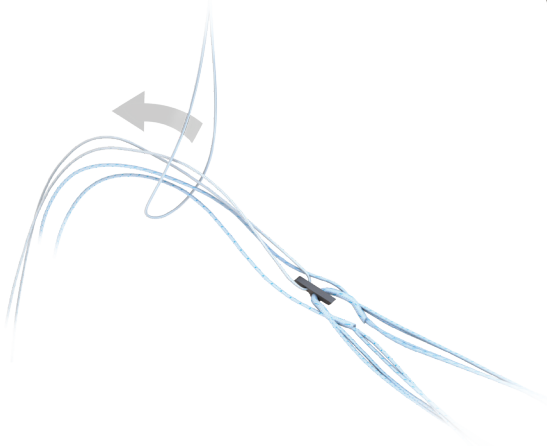

Figure 10

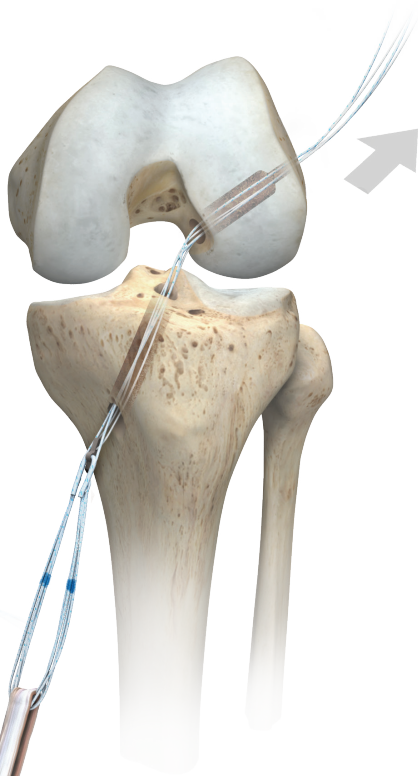

Figure 11

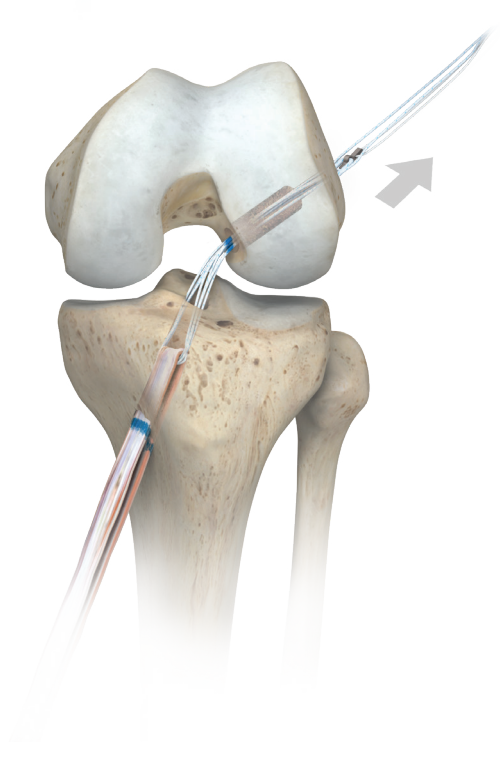

Figure 12

### Insert Implant into Tunnel (cont.)

Load the white ToggleLoc button passing suture and the zipping strands of the ToggleLoc Inline through the relay stitch (Figure 10).

Pull proximally on the relay stitch to pull the white ToggleLoc button passing suture and the zipping strands of the ToggleLoc Inline through the tibial tunnel, joint space and femoral tunnel, exiting through the skin (Figure 11).

The zipping strands now exit the lateral femoral cortex with the white ToggleLoc button passing suture. Simultaneously pull on the zipping strands and the white ToggleLoc button passing suture while maintaining back tension on the graft until the intraosseous tunnel mark on the ToggleLoc Inline is seen at the entry point to the femoral tunnel (Figure 12). This mark will indicate that the button is beyond the lateral femoral cortex.

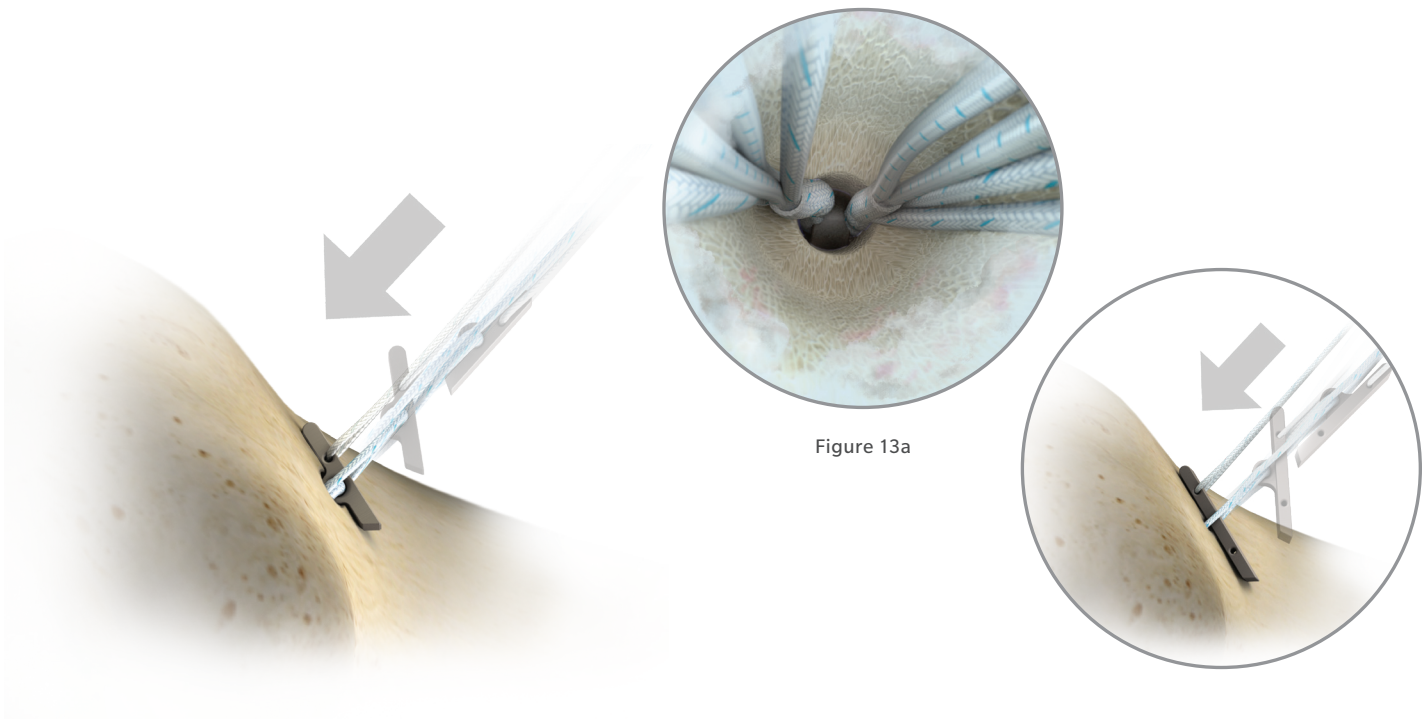

Figure 13

Figure 13a

Figure 13b

### Insert Implant into Tunnel (cont.)

As the button passes, ensure that the ToggleLoc Inline device is oriented laterally so it will deploy on the femur's lateral cortex (Figure 13). Pull back on the graft limbs to verify the button has deployed and is secure. The ToggleLoc Inline button can be visualized passing through the femoral tunnel by viewing through the accessory medial portal (Figure 13a).

In case of a blowout of the lateral femoral cortex, the ToggleLoc XL with ZipLoop Inline Fixation Device can be utilized (Figure 13b).

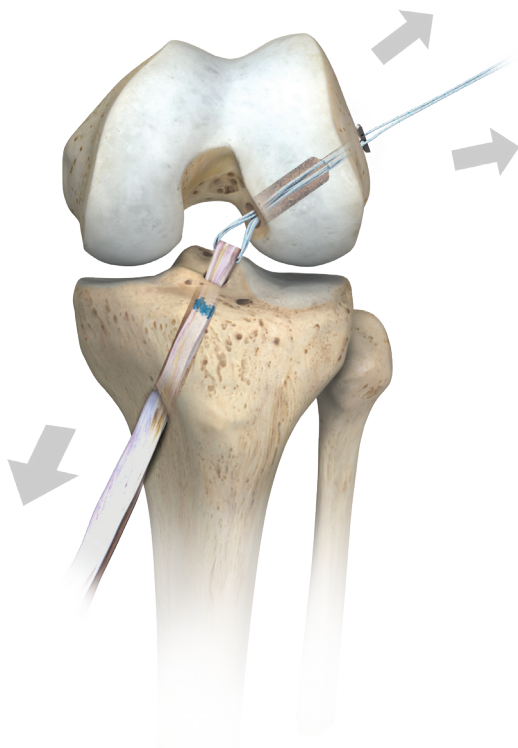

Figure 14

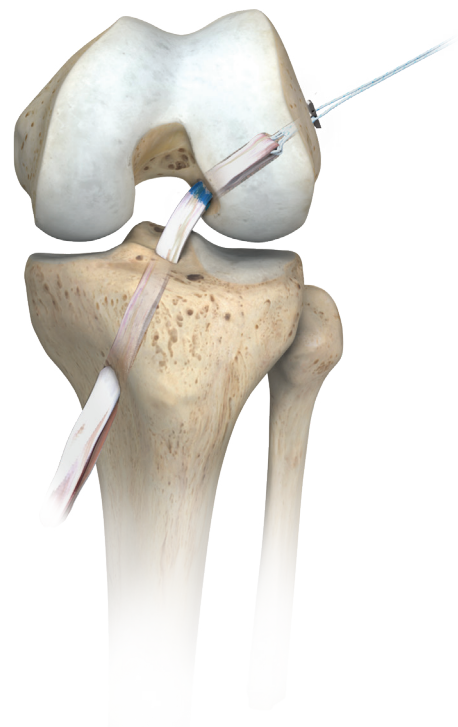

Figure 15

### Position Graft in Femoral Tunnel

Once the button is secured, pull on the zipping strands to advance the graft through the tibial tunnel and into the femoral tunnel. To zip the device, maintain light back tension on the graft from the tibial side. Then pull the zipping strands separately and alternating back and forth (Figure 14).

The graft will bottom out inside the femoral socket (Figure 15).

ⓘ **Note:** If re-tensioning the graft after tibial fixation is desired, make note not to bottom out the graft in the femoral tunnel.





Figure 16

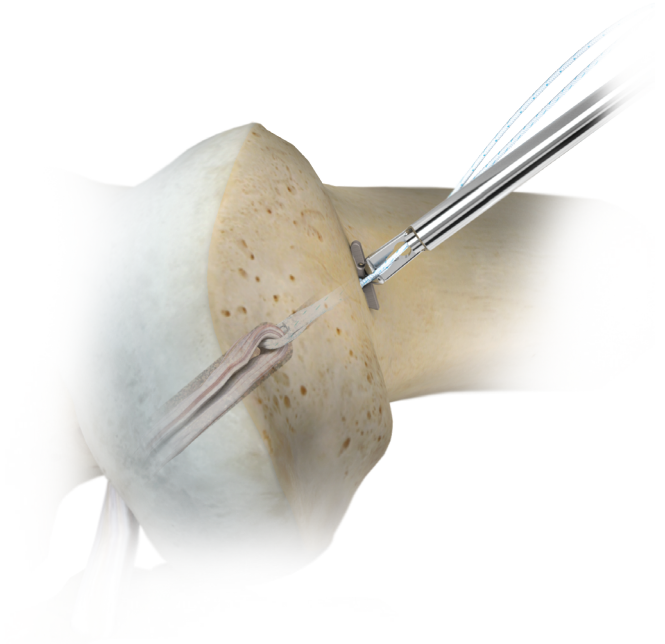

Figure 17

## Tibial Fixation

Reference the TunneLoc Tibial Fixation surgical technique for tibial fixation (0387.1-GLBL-en) (Figure 16).

Once tibial fixation is complete, advance the Super MaxCutter™ Suture Cutter down the zipping strands near the ToggleLoc Inline and cut the additional length to complete the femoral fixation (Figure 17).

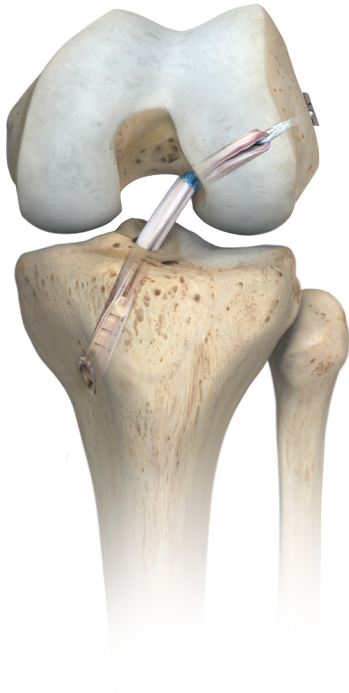

Figure 18

### **Tibial Fixation (cont.)**

Fixation is now complete (Figure 18).

### **Post-Op Protocol**

Patient is placed in an immobilizer or hinged knee brace depending on surgeon preference. Femoral nerve block and/or cold therapy can be used as well if not contraindicated. Patient follows a detailed postoperative therapy protocol to enhance healing and protect the graft. This protocol is modified depending on additional procedures performed during the case.

## Ordering Information

### Implants

Part Number	Size	Description
110005087		ToggleLoc with ZipLoop Inline Implant
110005090		ToggleLoc XL with ZipLoop Inline
110005089		ToggleLoc XL with ZipLoop
906512	8 mm	TunneLoc Tibial Fixation Device with Preloaded Implant
906513	9 mm	TunneLoc Tibial Fixation Device with Preloaded Implant
906514	10 mm	TunneLoc Tibial Fixation Device with Preloaded Implant
906515	11 mm	TunneLoc Tibial Fixation Device with Preloaded Implant
110003540		ExpressBraid™ Graft White Suture Single
110003463		ExpressBraid Graft White Suture 10pk
110003539		ExpressBraid Graft Blue/White Suture Single
110003464		ExpressBraid Graft Blue/White Suture 10pk

### Instrumentation

Part Number	Size	Description
110004136		Disposable ACL Kit
904794		Disposable ZipLoop Puller

## Instrumentation (cont.)

Part Number	Size	Description
110007425	4.5 mm	Calibrated Spade Tip Guide Pin
906570	7.0 mm	Low Profile Femoral Drill
906571	7.5 mm	Low Profile Femoral Drill
906572	8.0 mm	Low Profile Femoral Drill
906573	8.5 mm	Low Profile Femoral Drill
906574	9.0 mm	Low Profile Femoral Drill
906575	9.5 mm	Low Profile Femoral Drill
906576	10.0 mm	Low Profile Femoral Drill
906577	10.5 mm	Low Profile Femoral Drill
909590	6 mm	Medial Portal Femoral Aimers
909591	7 mm	Medial Portal Femoral Aimers
909592	8 mm	Medial Portal Femoral Aimers
909593	9 mm	Medial Portal Femoral Aimers
909594	10 mm	Medial Portal Femoral Aimers
909595	11 mm	Medial Portal Femoral Aimers
909596	12 mm	Medial Portal Femoral Aimers
909907	5.0 mm	Tibial Drill Bit
909908	5.5 mm	Tibial Drill Bit
909909	6.0 mm	Tibial Drill Bit
909910	6.5 mm	Tibial Drill Bit
909911	7.0 mm	Tibial Drill Bit
909912	7.5 mm	Tibial Drill Bit
909913	8.0 mm	Tibial Drill Bit
909914	8.5 mm	Tibial Drill Bit
909915	9.0 mm	Tibial Drill Bit
909916	9.5 mm	Tibial Drill Bit
909917	10.0 mm	Tibial Drill Bit
909919	11.0 mm	Tibial Drill Bit
909921	12.0 mm	Tibial Drill Bit
909923	13.0 mm	Tibial Drill Bit
900342		Super Maxcutter Suture Cutter

**INDICATIONS FOR USE (TOGGLELOC)**

The ToggleLoc System devices, except the ToggleLoc XL with ZipLoop devices, are intended for soft tissue to bone fixation for the following indications:

**Shoulder**

Bankart lesion repair  
 SLAP lesion repairs  
 Acromio-clavicular repair  
 Capsular shift/capsulolabral reconstruction  
 Deltoid repair  
 Rotator cuff tear repair  
 Biceps Tenodesis

**Foot and Ankle**

Medial/lateral repair and reconstruction  
 Mid- and forefoot repair  
 Hallux valgus reconstruction  
 Metatarsal ligament/tendon repair or reconstruction  
 Achilles tendon repair  
 Ankle Syndesmosis fixation (Syndesmosis disruptions) and as an adjunct in connection with trauma hardware for Weber B and C ankle fractures (only for ToggleLoc with Tophat/ZipTight™ Fixation Devices)

**Elbow**

Ulnar or radial collateral ligament reconstruction  
 Lateral epicondylitis repair  
 Biceps tendon reattachment

**Knee**

ACL/PCL repair / reconstruction  
 ACL/PCL patellar bone-tendon-bone grafts  
 Double-Tunnel ACL reconstruction  
 Extracapsular repair: MCL, LCL, and posterior oblique ligament  
 Iliotibial band tenodesis  
 Patellar tendon repair  
 VMO advancement  
 Joint capsule closure

**Hand and Wrist**

Collateral ligament repair  
 Scapholunate ligament reconstruction  
 Tendon transfers in phalanx  
 Volar plate reconstruction

The ToggleLoc XL device is used for fixation of tendons and ligaments during orthopedic reconstruction procedures, such as Anterior Cruciate (ACL) or Posterior Cruciate (PCL) Reconstruction, as well as fixation in cases of unanticipated intraoperative complications, such as cortical breaching.

**CONTRAINDICATIONS**

1. Infection.
2. Patient conditions including blood supply limitations, and insufficient quantity or quality of bone or soft tissue.
3. Patients with mental or neurologic conditions who are unwilling or incapable of following postoperative care instructions.
4. Foreign body sensitivity. Where material sensitivity is suspected, testing is to be completed prior to implantation of the device.

**INDICATIONS (TUNNELOC)**

To provide fixation of soft-tissue grafts within the tibial tunnel during anterior cruciate ligament (ACL) and/or posterior cruciate ligament (PCL) reconstruction.

**CONTRAINDICATIONS**

1. Active infection.
2. Patients with mental or neurologic conditions who are unwilling or incapable of following postoperative care instructions.
3. Patient conditions including: blood supply limitations, insufficient quantity or quality of bone for attachment or latent infections.
4. Pathologic soft tissue conditions, which would prevent secure fixations.

**INDICATIONS (EXPRESSBRAID)**

The ExpressBraid Graft Manipulation is intended for use in soft tissue approximation and/or ligation. The suture may be provided individually or be incorporated as a component, into surgeries where constructs including those with allograft or autograft tissue are used for repair.

**CONTRAINDICATIONS**

1. ExpressBraid Graft Manipulation is not for use in cardiac indications.
2. ExpressBraid Graft Manipulation is not for use in direct contact with the central nervous system.